

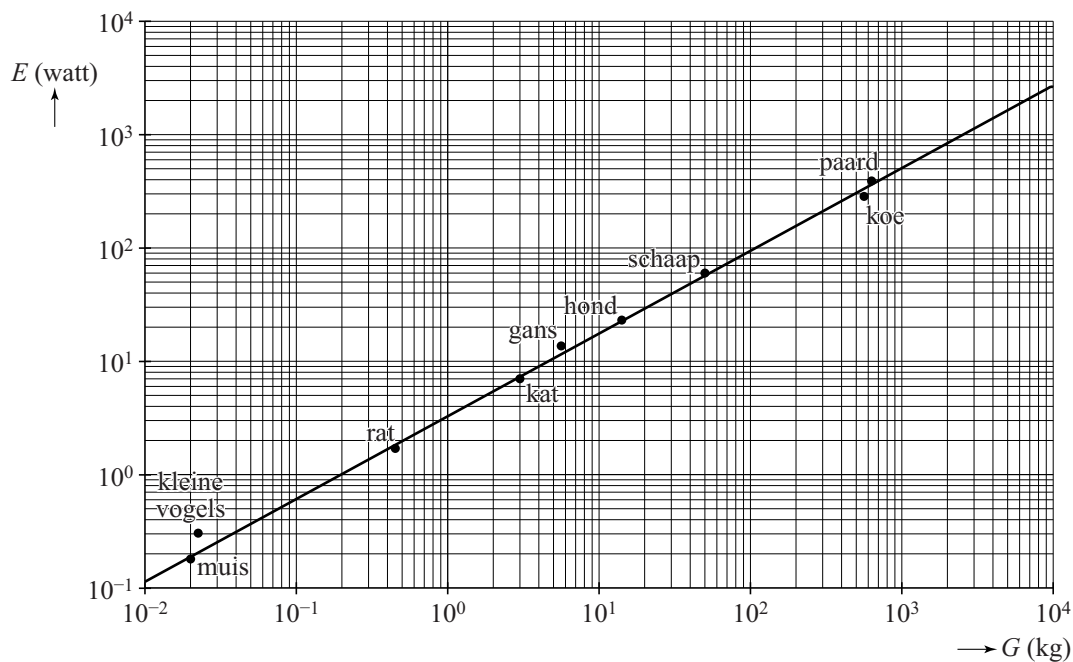











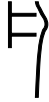

uitwerkbijlage









Naam kandidaat _____ Kandidaatnummer _____

3



| | klinker 1 | klinker 2 |
|---------------|--|---|
| medeklinker 1 |  = ti |  |
| medeklinker 2 |  |  |
| medeklinker 3 |  = ni |  |
| medeklinker 4 |  |  |
| medeklinker 5 |  |  |





A - mi - ni - so

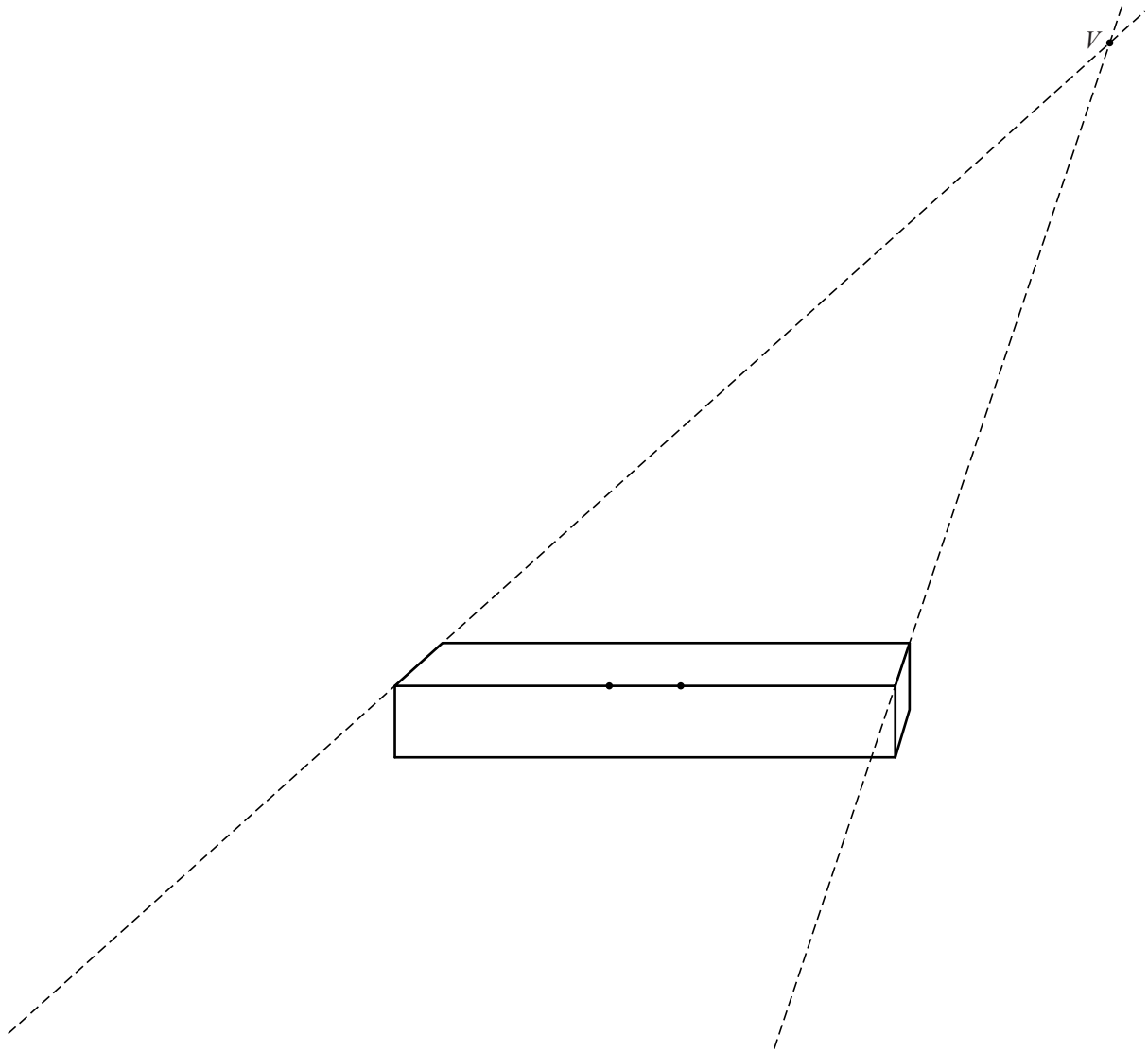







 woord 1 woord 2 woord 3





VERGEET NIET DEZE UITWERKBIJLAGE IN TE LEVEREN